

canopyLINK

Sensor Interface for Canopy Monitoring

Contents

- Specifications 01
- Overview 02
- Warnings and Notices 03-04
- Installation Instructions 04-06
- Device Registration 07-08
- Device Connections 09
- Technical Information 10-11
- Warranty 12



Specifications

Input Power	24VDC - Class II/Limited Energy Power Supply
Compatible Sensors	Climalink, Terralink, Terralink+ Acclima TDR, ESM3, *TEROS 12 <i>* Some devices may require an adapter for port connection.</i>
Protocols	SDI-12
Number of Sensor Ports	8x - One Sensor Per Port
Sensor Addressing	Automatic
Interface	HUB Connection Port, 2.4GHz Wi-Fi
Sensor Port Connection	M8
Dimensions	6.5"W x 2.875"H x 1.125"D (165mm x 73mm x 28.5mm)

 **KEEP THESE INSTRUCTIONS**

Overview

The canopyLINK connects up to eight (8) compatible sensors to Growlink and must always be powered using the included 24VDC power adapter. When operating over Wi-Fi (without a HUB), the 24VDC power adapter is required for proper functionality. Sensors are automatically detected upon connection, with no special addressing necessary.

Any compatible sensor can be connected to the canopyLINK sensor hub. Adapters for various sensor ends are available if the sensor doesn't include an M8 4-pin female connection.

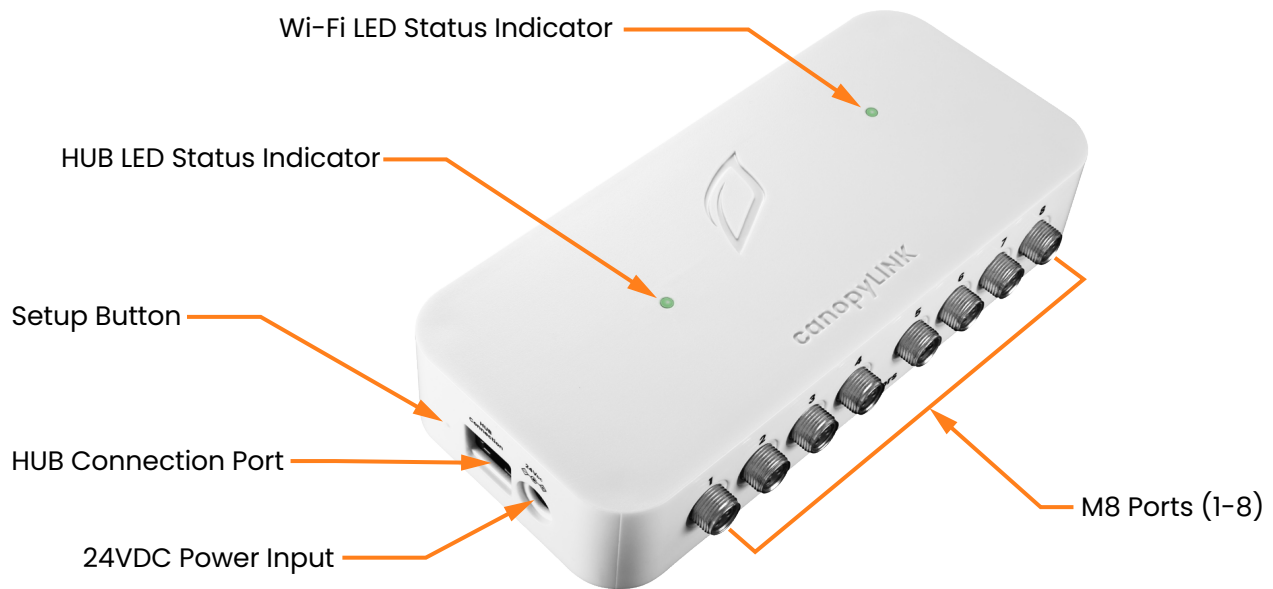

External Features

Wi-Fi LED Status Indicator: Indicates Wi-Fi connection status.

HUB LED Status Indicator: Indicates device power and HUB communication status.

Setup Button: Initiates setup mode and readdresses the canopyLINK module.

HUB Connection Port: RJ-45 connector port for data.

24VDC Power Input: Input for 24VDC from included 24VDC power adapter.

M8 Port (x8): M8 connector ports for compatible sensors.

Warnings and Notices

This is a precision electronic instrument that requires careful handling and maintenance to ensure reliability. Failure to read, understand, and comply with warnings and installation requirements may result in property damage, personal injury, or death.

WARNING

READ & UNDERSTAND THE ENTIRE MANUAL BEFORE INSTALLATION OR OPERATION.

Danger: Electrocution Hazard

Disconnect power before performing maintenance or service on the system or its components to prevent equipment damage or electrical shock. Ensure proper grounding at the marked chassis ground terminal for continued protection against electric shock. All electrical equipment and wiring must be installed in compliance with national and local electrical codes. This product is for indoor use only in dry locations (0–75% RH, non-condensing). Use caution when servicing plumbing and drain the system away from electrical components and connections. Connect the system and components to GFCI fault-protected energy sources to reduce the risk of electric shock. Replace serviceable parts only with manufacturer-recommended components.

IMPORTANT SAFETY INFORMATION

This Product Is Not Intended for Life Safety Applications

Do not install in hazardous locations. Do not rely on this equipment as the sole control mechanism for life safety applications.

Installation Requirements

Follow all applicable plumbing and electrical codes when installing this product. This manual is intended for individuals with adequate electrical and mechanical experience who comply with federal, state, and local laws governing the installation, service, and repair of electrical, HVAC, and related equipment. Incorrect installation, service, or repair may result in personal injury and/or property damage. The manufacturer and seller assume no liability for misinterpretation or improper use of the information provided.

Indoor Use Only

This product is designed for indoor mounting only and must be protected from weather and direct sunlight.

Prevent Overheating

Maintain adequate airflow around the system to prevent overheating of system components.

Network Security

This product is a network-connected device and must be installed in a location inaccessible to unauthorized individuals. Failure to do so may result in unauthorized tampering with the device, its configuration, or network connectivity, potentially disrupting network operation or system performance.

Power Supply Warning

Only use the intended or included power supply. Do not exceed the maximum ratings specified on the product's serial label or in this manual. Any power supply exceeding specified energy levels must be current-limited or fused to prevent overcurrent damage.

Dielectric Grease Recommendation

In humid environments, apply dielectric grease to RJ-45 HUB connections to prevent moisture-related corrosion. Recommended products include Loctite LB 8423 Grease, DuPont Molykote 4/5, CRC 05105 Di-Electric Grease, Super Lube 91016 Silicone Dielectric Grease, and other silicone or lithium-based insulating greases. Apply a small amount of grease to RJ-45 plug contacts before inserting them into the HUB connection port.

California Proposition 65 Warning

This product may contain chemicals known to the State of California to cause cancer, birth defects, or other reproductive harm. Wear skin and eye protection when handling hazardous chemicals.

Installation Instructions

Before Installation

For optimal protection, install the unit with the power connection facing downward to minimize the risk of water entering the enclosure. This product is designed for indoor installation only, as the enclosures are not waterproof.

Before connecting or disconnecting any cables, disconnect power from all devices to prevent potential damage to components.

Mounting the Enclosure

For optimal performance and easy service access, mount the canopyLINK outside the growing area to reduce exposure to humidity and moisture. If installed in a humid environment, use a sealed or weatherproof enclosure. Mount above plants, benches, and cable runs to prevent water damage to connectors and circuitry. Position centrally to sensor locations with enough space for all connections. Account for rolling benches, and use Growlink cable extensions if needed.

Follow these tips for best results:

- Mount the canopyLINK away from drips, condensation, and water equipment such as misters, foggers, and humidifiers.
- Ensure space for connections and service access.
- Use a weatherproof enclosure for high humidity conditions (<70% continuous).
- Cover open jacks with masking tape to prevent dust or contamination.

Wall Mounting

See Instructions and Diagram Below

Parts: LINKS Device, LINK Hardware Kit (Mounting Bracket, Screws, Anchors, Mini-Screwdriver).

Tools Needed (if necessary): Level, Marking Tool, Drill

1. Attach the **Device Mount Bracket (Top)** with the provided screws. Ensure the counter-sunk holes face forward. Do not over-tighten.
2. Position the **Wall Mount Bracket (Bottom)** on the wall. Mark the hole locations and install anchors or pre-drill holes if necessary.
3. Slide the **Device** into place, aligning the **(Top) Device Bracket** with the **(Bottom) Wall Mount Bracket**.

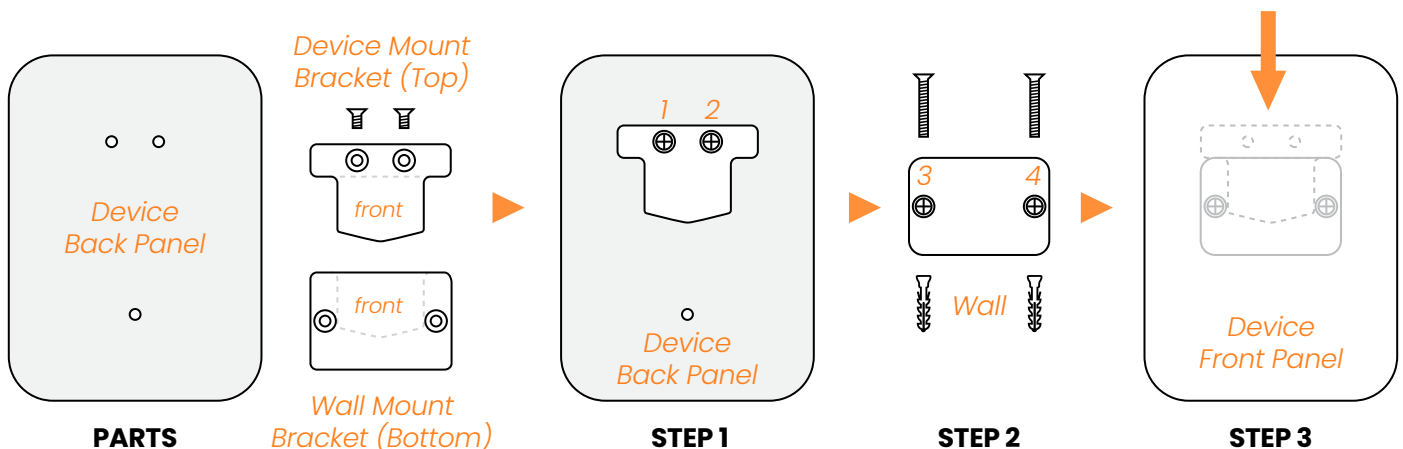

DIN rail Mounting

The DIN rail mounting clips come in handy where standard DIN rail is used for mounting devices. The flat mounting surface and a variety of mounting holes make these clips versatile for mounting LINK devices.

See Instructions and Diagram Below

Parts: LINKS Device, DIN rail Clip Kit, (Sold Separately)

Tools Needed (if necessary): Phillips Screwdriver

1. Position at an Angle

Hold the device at a slight angle with the top part of the DIN rail clip hooking onto the top edge of the rail first. Ensure proper alignment to avoid unnecessary force on the clip.

2. Snap into Place

Gently rotate the bottom of the device toward the rail while applying light pressure. The spring-loaded or flexible lower clip should compress slightly and then snap into place once fully engaged.

3. Verify Secure Fit

Check that the device is firmly seated on the rail by giving it a gentle tug. It should not shift or wobble excessively.

4. Careful Removal: Lift and Pivot

To remove, compress the spring of the mount by gently pressing the device upwards. Once spring is compressed, tilt the top of the device outward at an angle. Then, once top is free, guide device downwards to release from DIN rail completely. Do not force or twist to prevent breaking plastic parts.

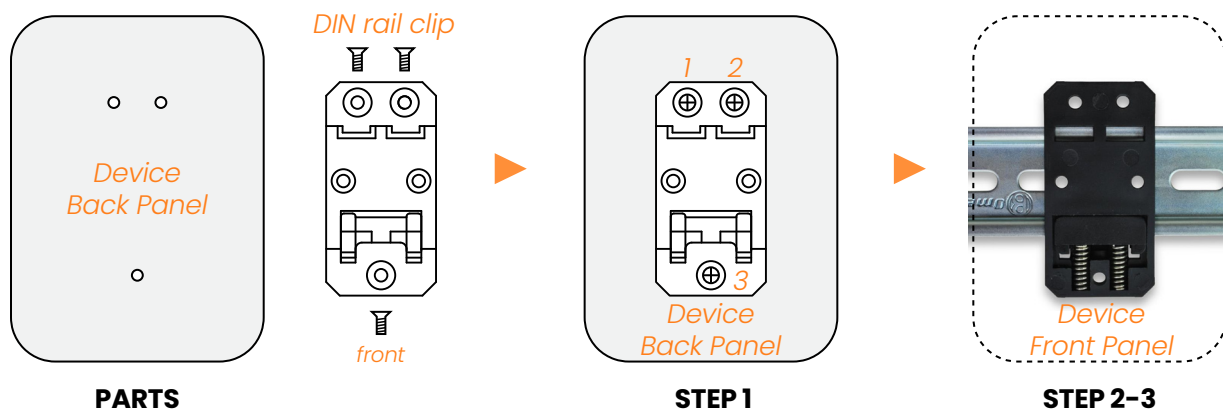

Device Registration

All LINKS devices require an internet connection and must be registered through the Growlink App.

Note: Some LINKS devices can be standalone or require additional modules.

HUB Connection Method

Connect the canopyLINK to an available HUB connection port using an unshielded RJ-45 cable. The device draws power through the network cable upon connection. Ensure the RJ-45 cable is secure, then proceed with manual registration.

Note: A HUB must be registered with the Growlink App before connecting any additional devices. After completing the HUB setup, each device must be connected and registered one at a time to ensure proper addressing and system integrity.

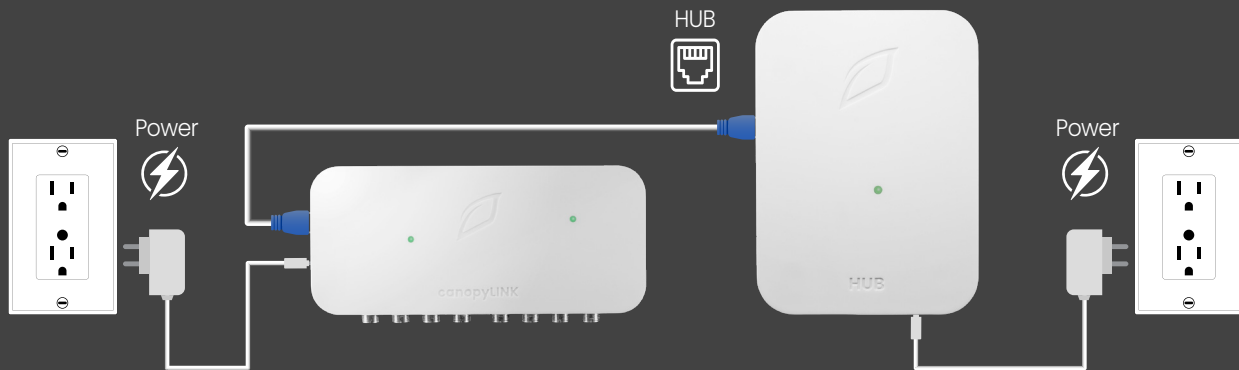

Wi-Fi Connection Method

The canopyLINK operates using only the included power supply. During device registration, a strong signal is recommended, and a password-protected connection is required.

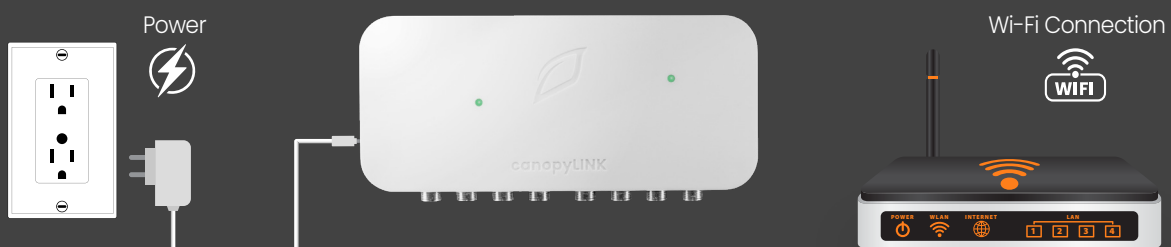

Connection to the Growlink App

The Growlink Mobile App provides remote access to your grow operation, allowing real-time monitoring, system adjustments, and automation of climate, lighting, and irrigation. The app features advanced analytics, push notifications for alerts, and an intuitive interface for efficient management.

The Growlink Mobile App enables remote control over your LINKS devices for:

- Firmware Updates
- Manual Device Operation
- Creating Automation Rules
- Viewing Data
- Sending Alerts
- Various Other Features

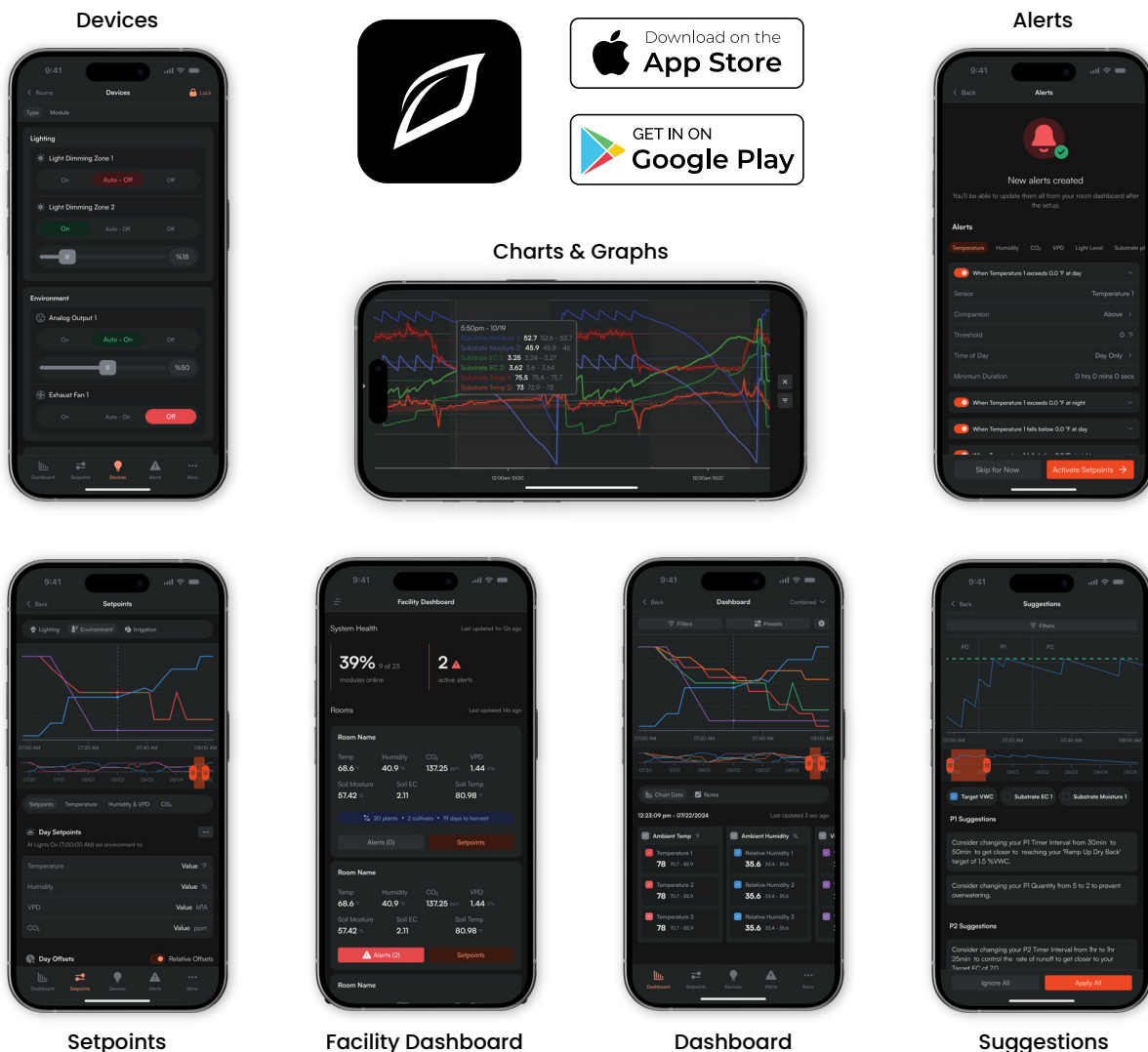

Device Connections

The canopyLINK is a sensor interface device designed for precision monitoring of your growing environment. It features eight sensor channels, supporting a wide range of canopy data inputs including substrate, climate, and light levels. The canopyLINK must always be powered using its included 24VDC power adapter and connects directly to the Growlink HUB—either via wired connection or Wi-Fi. For sensor compatibility, the device uses 4-pin male M8 threaded connections. If your sensors do not have the corresponding 4-pin female M8 connectors, adapter cables are required. Growlink provides a variety of adapters to ensure proper fit and reliable data transmission.

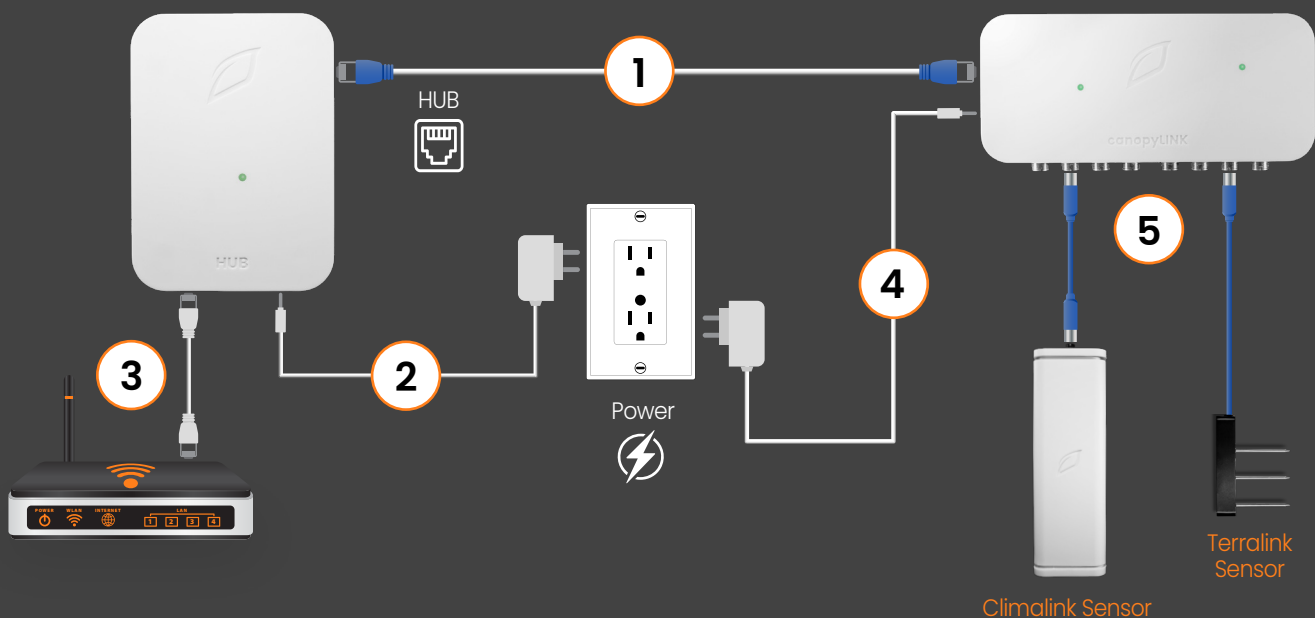

- 1. Device Cable:** Connects the canopyLINK to a HUB Connection Port.
- 2. HUB Power Supply:** 24VDC/1 Amp power supply is required to operate the HUB.
- 3. HUB Ethernet Cable:** Connect the HUB to the local network (Optionally, utilize 2.4GHz Wi-Fi).
- 4. canopyLINK Power Supply:** 24VDC Power Supply
- 5. canopyLINK M8 Inputs:** Sensor port connections (x8)

All HUB connection cabling uses standard 8-conductor RJ-45 straight-through wiring with no cross-over. T568B pattern recommended.

Technical Information

This canopyLINK provides 12VDC to SDI-12 sensors via M8 cable connections. Adapter cables are available from Growlink.

Compatible Sensors:

- Climalink
- Terralink
- Terralink+
- Acclima TDR
- ESM3
- * TEROS 12

** Some devices may require an adapter for connection.*

Troubleshooting

Wi-Fi LED Status Indicators



Standard Startup Flow

- Firmware Startup
Solid white
- Wi-Fi Connecting
Slow flashing green
- Network Waiting on IP Address
Fast flashing green
- Network Connected, Connecting to Cloud
Fast flashing cyan
- Loading Configuration and Detecting Probes
Fast breathing green
- Connected to Cloud and Running
Slow breathing green

Other Modes

- Wi-Fi Configuration Mode
Slow flashing blue
- Safe Mode
Slow breathing magenta
- Safe Mode Requested
Fast flashing magenta
- Firmware Updating
Slow flashing magenta
- Module Mode
Breathing cyan
- Wi-Fi Error
Flashing yellow

Support

If your device requires troubleshooting beyond what is outlined in this manual, please contact our customer support team at 800.432.0160 or at support@growlink.com for assistance with any hardware issues.

You can also visit our knowledge base for additional support and resources.
<https://knowledgebase.growlink.ag>

Maintenance & Service

Exterior Cleaning

Wipe the exterior with a damp cloth and mild dish detergent, then dry thoroughly. **Disconnect power before cleaning** to prevent equipment damage.

Storage

Store equipment in a **clean, dry environment** with an ambient temperature between 50–122°F (10–50°C).

Disposal

This industrial control equipment may contain traces of lead, metals, or other environmental contaminants. **Do not discard as municipal waste.** Dispose of the equipment through proper recycling or hazardous waste collection channels. **Wash hands after handling internal components or PCBs.**

Warranty

Growlink Limited Warranty

Growlink warrants that all its manufactured products are, to the best of its knowledge, free from defects in materials and workmanship. This product is warranted for one (1) year from the date of purchase. This warranty is extended to the original purchaser from the date of receipt.

This warranty does not cover damages resulting from abuse, accidental breakage, or modifications, alterations, or installations that do not comply with the provided installation instructions. The warranty applies only to products that have been properly stored, installed, and maintained in accordance with the installation and operation manual and used for their intended purpose.

This limited warranty does not cover products installed or operated under unusual conditions or environments, including but not limited to excessive humidity or extreme temperatures beyond specified limits.

Prior to returning a product, Growlink must be contacted to obtain a return authorization. Returns will not be accepted without prior authorization. For products not purchased directly from Growlink, proof of purchase is required; otherwise, the purchase date will be considered the date of manufacture.

Products that meet the warranty conditions outlined above will be repaired or replaced at Growlink's sole discretion at no charge. This warranty is provided in place of all other warranties, express or implied, including but not limited to any implied warranties of merchantability or fitness for a particular purpose, and is limited to the specified warranty period.

Under no circumstances shall Growlink be liable to the claimant or any third party for damages exceeding the purchase price of the product. Growlink is not responsible for any loss of use, inconvenience, commercial loss, lost time, lost profits, lost savings, or any other incidental, consequential, or special damages arising from the use or inability to use the product. This disclaimer is made to the fullest extent permitted by law and explicitly states that Growlink's liability under this limited warranty, or any extension thereof, is limited to repairing or replacing the product or refunding the purchase price.